



**370-2042****SIFONE DI SCARICO TELESCOPICO A BOTTIGLIA BOB**





Sifone di scarico telescopico a bottiglia, tondo. Materiale ottone. Canotto regolabile 120/320 mm.

				/ UM
370-2042-07	1"1/4 Cromo	1	52,55	



**370-2052****SIFONE DI SCARICO QUADRO TED**





Sifone di scarico telescopico, quadro. Materiale ottone. Canotto regolabile 120/320 mm.

				/ UM
370-2052-07	1"1/4 Cromo	1	65,39	



**370-X00****SIFONE AD S SENZA PILETTA CON CANNA DA CM.25 MODELLO LUX**

Categoria LUX

				/ UM
370-X00-06	1"	1	15,63	
370-X00-07	1"1/4	1	17,98	



sifoni in ottone, sturatubi

**370-X01**

**SIFONE AD S A COLONNA SENZA PILETTA CON  
CANNA DA CM.25 MODELLO LUX**



Categoria LUX

Icona	Modello	Dimensione	Quantità	Prezzo / UM
	370-X01-06	1"	1	16,02
	370-X01-07	1"1/4	1	18,37



**370-X02**

**SIFONE A BOTTIGLIA SENZA PILETTA CON  
CANNA DA CM.25 MODELLO LUX**







Categoria LUX

Icona	Modello	Dimensione	Quantità	Prezzo / UM
	370-X02-06	1"	1	16,41
	370-X02-07	1"1/4	1	19,15





**370-239****PILETTA LAVABO CLICK-CLACK CON VITE LUX**

Piletta click-clack per lavabo, con tappo coprente in ottone pesante lusso, fissaggio con vite per spessori igienici universali in ceramica e vetro da 0 a 70 mm con e senza foro troppo pieno. Dotata di regolazione chiusura tappo.

				/ UM
370-239	1" 1/4	1		<b>16,67</b>



**DIANHYDRO®****370-2390****PILETTA LAVABO CLICK-CLACK LEM**

Piletta lavabo click-clack. Idonea per lavabi con e senza troppo pieno.

				/ UM
370-2390-NE	Nera	1		<b>21,63</b>

**DIANHYDRO®****370-2401****PILETTA LAVABO CLICK-CLACK TAPPO TONDO CON TROPPO PIENO LUX**

Piletta Click-Clack in ottone cromato con troppo pieno, tappo coprente tondo per lavabo spessore minimo 30mm - max 45mm. Dotata di tappo estraibile.



				/ UM
370-2401	1" 1/4	1		<b>19,62</b>

**DIANHYDRO®**

## pilette in ottone





**370-24110****PILETTA CLICK-CLACK LAVABO "FANCY" SENZA TROPPO PIENO**

Piletta lavabo click-clack 1"1/4, con tappo in ceramica tondo.

				/ UM
370-24110-AR	Arancio	1	52,99	





**370-24111****PILETTA CLICK-CLACK LAVABO "FANCY" CON TROPPO PIENO**

Piletta lavabo click-clack 1"1/4, con tappo in ceramica tondo.

				/ UM
370-24111-AR	Arancio	1	52,99	

**370-24120****PILETTA CLICK-CLACK LAVABO "FANCY MATT" SENZA TROPPO PIENO**

Piletta lavabo click-clack 1"1/4, con tappo in ceramica tondo.





				/ UM
370-24120-BI	Bianco Opaco	1	56,08	
370-24120-NE	Nero Opaco	1	56,08	





## PILETTA CLICK-CLACK LAVABO "FANCY MATT" CON TROPPO PIENO

Piletta lavabo click-clack 1"1/4, con tappo in ceramica tondo.

				/ UM
370-24121-BI	Bianco Opaco	1		<b>56,08</b>
370-24121-NE	Nero Opaco	1		<b>56,08</b>



**DIANHYDRO**

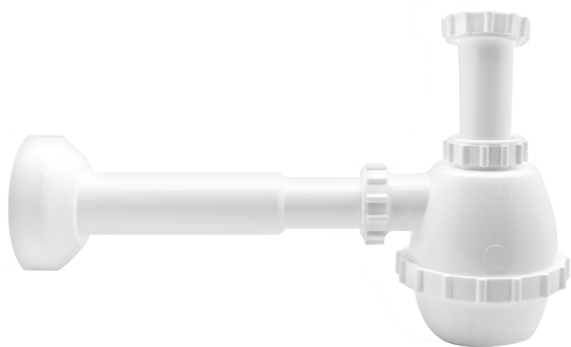

**371-300****SIFONE PVC 1 VIA S / PILETTA PER PORCELLANA CON CANOTTO**

Sifone dotato di un canotto speciale che collega il sifone con ingresso diam. 32, allo scarico a muro con uscita diam. 40. Il corpo sifone rimane solito, con ingressi da diam. 32.

 371-300	 1"1/4	 40	 / UM
			<b>3,84</b>





**DIANHYDRO****371-301****SIFONE PVC 2 VIE S / PILETTA PER PORCELLANA CON CANOTTO**

Sifone dotato di un canotto speciale che collega il sifone con ingresso diam. 32, allo scarico a muro con uscita diam. 40. Il corpo sifone rimane solito, con ingressi da diam. 32.

 371-301	 1"1/4	 30	 / UM
			<b>6,05</b>

**DIANHYDRO****371-302****SIFONE PVC 1 VIA C / PILETTA PER PORCELLANA CON CANOTTO**





Sifone dotato di un canotto speciale che collega il sifone con ingresso diam. 32, allo scarico a muro con uscita diam. 40. Il corpo sifone rimane solito, con ingressi da diam. 32.

 371-302	 1"1/4	 35	 / UM
			<b>6,38</b>

**DIANHYDRO**



**371-303****SIFONE PVC 2 VIE C / PILETTA PER PORCELLANA CON CANOTTO**

Sifone dotato di un canotto speciale che collega il sifone con ingresso diam. 32, allo scarico a muro con uscita diam. 40. Il corpo sifone rimane solito, con ingressi da diam. 32.

				/ UM
371-303	1"1/4	25	10,13	



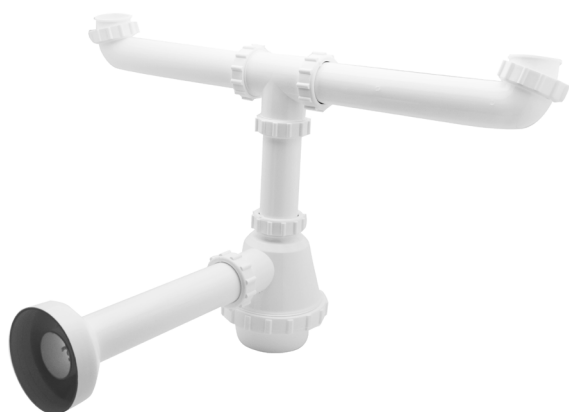

**DIANHYDRO®****371-310****SIFONE PVC 1 VIA S / PILETTA PER INOX**

Nuovo corpo sifone con scarichi interamente del diametro 40 come da nuove normative europee.

				/ UM
371-310	1"1/2 Diam. 40	35	4,45	

**DIANHYDRO®****371-311****SIFONE PVC 2 VIE S / PILETTA PER INOX**



Nuovo corpo sifone con scarichi interamente del diametro 40 come da nuove normative europee.

				/ UM
371-311	1"1/2 Diam. 40	20	6,54	

**DIANHYDRO®**



**371-320****SIFONE PVC 1 VIA C / PILETTA E SCARICO  
LAVATRICE C/CANOTTO**

Sifone dotato di un canotto speciale che collega il sifone con ingresso diam. 32, allo scarico a muro con uscita diam. 40. Il corpo sifone rimane solito, con ingressi da diam. 32.

 371-320	 1"1/4	 35	 / UM
			<b>7,00</b>



**DIANHYDRO****371-321****SIFONE PVC 2 VIE C / PILETTA E SCARICO  
LAVATRICE C/CANOTTO**

Sifone dotato di un canotto speciale che collega il sifone con ingresso diam. 32, allo scarico a muro con uscita diam. 40. Il corpo sifone rimane solito, con ingressi da diam. 32.

 371-321	 1"1/4	 20	 / UM
			<b>11,14</b>

**DIANHYDRO****371-322****SIFONE PVC 1 VIA S / PILETTA E SCARICO  
LAVATRICE**

Nuovo corpo sifone con scarichi interamente del diametro 40 come da nuove normative europee.

 371-322	 1"1/2 Diam. 40	 30	 / UM
			<b>6,69</b>

**DIANHYDRO**







**371-323**



### SIFONE PVC 2 VIE S / PILETTA

Nuovo corpo sifone con scarichi interamente del diametro 40 come da nuove normative europee. Senza scarico lavatrice.

				/ UM
371-323	1"1/2 Diam. 40	20	8,82	



**DIANHYDRO®**

**371-11160Y****2 PZ GHIERE DI RICAMBIO PER TROPPO PIENO  
IN ABS CROMO BLISTER**

Icona	Modello	Descrizione	Quantità	Prezzo / UM
	371-11160Y-19	Diam. 19	1	2,02
	371-11160Y-24	Diam. 24	1	2,02
	371-11160Y-28	Diam. 28	1	2,06

**371-M2001Y****GRIGLIA INOX PER PILETTA LAVELLO BLISTER**

Icona	Modello	Descrizione	Quantità	Prezzo / UM
	371-M2001Y	-	1	1,55

**371-M2002Y****GRIGLIA INOX PER PILETTA LAVELLO "STOPPER"  
BLISTER**

Icona	Modello	Descrizione	Quantità	Prezzo / UM
	371-M2002Y	Diam. 80	1	1,99
	371-M2002Y-070	Diam. 70	1	1,86



**371-M2003Y**GRIGLIA DIAM. 9 CM PER FORO LAVELLO DIAM.  
4.5 CM BLISTER

In PP.

Icona	Modello	Descrizione	Quantità	Prezzo / UM
	371-M2003Y-BI	Bianca	1	1,41
	371-M2003Y-CR	Cromo	1	2,22

**DIAN****371-M3093Y**TAPPO CESTELLO MOD. MUX PER PILETTA  
BLISTER

Per piletta 3" 1/2.

Icona	Modello	Descrizione	Quantità	Prezzo / UM
	371-M3093Y	Diam. 83	1	5,06

**DIAN****371-M3094Y**TAPPO CESTELLINO INOX DM 52 MOD. LUX PER  
PILETTA BLISTER

Per piletta Diam. 70



Icona	Modello	Descrizione	Quantità	Prezzo / UM
	371-M3094Y	-	1	4,21

**DIAN**



## NIPPLE DOPPIO FILETTO MASCHIO BLISTER

Raccordi in plastica.

 372-405Y	 <i>Diam. 3/4 x 3/4</i>	 1	 / UM	<b>1,22</b>
--	--	---	--	-------------



**DIAN**



## TUBO CARICO LAVATRICE FF F-BRICO

Fornito senza guarnizioni (nostro articolo 200-248).

				/ UM
372-339F-15	FF 3/4" x 150 cm	1		3,18
372-339F-20	FF 3/4" x 200 cm	1		3,61
372-339F-25	FF 3/4" x 250 cm	1		4,14
372-339F-30	FF 3/4" x 300 cm	1		4,63



## 372-440F



## TUBO CARICO LAVATRICE CON CURVA F-BRICO

Fornito senza guarnizioni (nostro articolo 200-248).

				/ UM
372-440F-15	mt. 1.50	1		3,27
372-440F-20	mt. 2.00	1		3,71
372-440F-25	mt. 2.50	1		4,24
372-440F-30	mt. 3.00	1		4,72



## 372-441F



## TUBO SCARICO LAVATRICE UNIVERSALE F-BRICO

Tubo di scarico lavatrice flessibile corrugato. Raccordi integrati. Adattabile a tutte le posizioni di attacco. Unico prodotto per tutte le lavatrici e lavastoviglie in commercio.

				/ UM
372-441F-15	mt. 1,50	1		1,77
372-441F-20	mt. 2,00	1		2,11
372-441F-25	mt. 2,50	1		2,38

